

## Errata

***Product Manual for the Dionex IonPac™ Ultra Trace Anion Concentrator (UTAC)***  
*065091-04*

For new orders of the following parts discussed in this manual, please use the updated part numbers listed below.

<b>Part</b>	<b>Old Part Number in this manual</b>	<b>Updated Part Number to use for new orders</b>
<i>ASSY,COIL,2ML/MIN,1000PSI,EG40</i>	<i>053763</i>	<i>AAA-053763</i>



# PRODUCT MANUAL

for the

**IonPac<sup>®</sup>**

**Ultra Trace Anion Concentrator**  
(UTAC-LP1, UTAC-ULP1 and UTAC-XLP1)

Now sold under the  
Thermo Scientific brand

**Thermo**  
SCIENTIFIC

Part of Thermo Fisher Scientific

 **DIONEX**

IC | HPLC | MS | EXTRACTION | PROCESS | AUTOMATION

**PRODUCT MANUAL**

**FOR**

**IONPAC ULTRA TRACE ANION CONCENTRATOR**  
**(UTAC)**

**UTAC-LP1 Column – Low Pressure, 4 x 35 mm (P/N 063079)**  
**UTAC-ULP1 Column – Ultra Low Pressure, 5 x 23 mm (P/N 063475)**  
**UTAC-XLP1 Column – Extremely Low Pressure, 6 x 16 mm (P/N 063459)**

**Dionex® Corporation, 2010**  
**Document No. 065091**  
**Revision 04**  
**September 2010**

## TABLE OF CONTENTS

<b>IMPORTANT INFORMATION</b> .....	<b>3</b>
<b>1. INTRODUCTION</b> .....	<b>4</b>
<b>2. INSTALLATION</b> .....	<b>6</b>
<b>2.1. Column Description</b> .....	<b>6</b>
<b>3. UTAC SETUP</b> .....	<b>7</b>
<b>4. OPERATION</b> .....	<b>7</b>
<b>4.1. Sample Loading</b> .....	<b>7</b>
<b>4.2. Reagent and Sample Handling</b> .....	<b>9</b>
4.2.1. Water Quality.....	9
4.2.2. Sample Collection and Storage.....	9
4.2.3. Standards.....	9
<b>4.3. Concentrator Capacity</b> .....	<b>10</b>
4.3.1. Determination of the Concentrator Column Breakthrough Volume.....	11
<b>5. EXAMPLE APPLICATIONS</b> .....	<b>13</b>
<b>5.1. Manual Concentration on UTAC-LP1 versus 1 mL Direct Injection</b> .....	<b>13</b>
<b>5.2. Manual Concentration on UTAC-LP1 versus 2 mL Direct Injection</b> .....	<b>14</b>
<b>6. TROUBLESHOOTING GUIDE</b> .....	<b>15</b>
<b>6.1. High Backpressure from a Contaminated Inlet Bed Support</b> .....	<b>15</b>
<b>6.2. High Background, Noise, or Baseline Instability</b> .....	<b>16</b>
<b>6.3. Poor Peak Shape</b> .....	<b>16</b>
<b>APPENDIX A</b> .....	<b>17</b>
<b>COLUMN CARE</b> .....	<b>17</b>

---

## IMPORTANT INFORMATION

Several icons are used throughout this document to emphasize important points. The symbols are shown below, along with the purpose of the information.



**SAFETY**

*Safety information can help prevent bodily harm.*



**WARNING**

*Warning information can help prevent equipment harm.*



**CAUTION**

*Caution information can help prevent problems.*



**NOTE**

*Note information can help with tips for improved use.*

## SECTION 1 – INTRODUCTION

The IonPac Ultra Trace Anion Concentrator – Low Pressure (UTAC-LP1), the IonPac Ultra Trace Anion Concentrator – Ultra Low Pressure (UTAC-ULP1), and the IonPac Ultra Trace Anion Concentrator – Extremely Low Pressure (UTAC-XLP1) columns are designed primarily to eliminate or minimize the sulfate blanks during trace level analysis of anions in matrices such as high purity water. The function of the UTAC column is to strip ions from a measured volume of a relatively clean aqueous sample matrix. This process “concentrates” the desired analyte species onto the UTAC concentrator, leading to a lowering of detection limits by 2-5 orders of magnitude. The unique advantage of the UTAC column to the analytical chemist is the capability of performing routine trace analyses of sample matrix ions at  $\mu\text{g/L}$  levels without extensive and laborious sample pretreatment.

The UTAC-LP1, UTAC-ULP1, and UTAC-XLP1 are packed with an 17  $\mu\text{m}$  styrene/divinylbenzene copolymer that is synthesized with carboxylate functionality for further agglomeration with an anion exchange latex that has been completely aminated. The latex has a polyvinyl benzyl backbone and carries the actual anion exchange sites. Due to the highly cross-linked structure, the resin is solvent compatible. The UTAC-ULP1 and UTAC-XLP1 use column hardware with a wider internal diameter of 5-mm and 6-mm, and a shorter length, thereby decreasing the column backpressure but maintaining the column capacity. The capacity of the UTAC-LP1, UTAC-ULP1, and UTAC-XLP1 is approximately 25  $\mu\text{eq/column}$  with a void volume of approximately 145  $\mu\text{L}$ . The physical rigidity of this resin allows the UTAC columns to be used at pressures up to 3,000 psi. The UTAC-LP1, UTAC-ULP1, or UTAC-XLP1 can be readily converted between the base and the salt form without significant changes in the operating pressure.

The recommended maximum flow rate is 3 mL/min. The backpressure generated by the UTAC-LP1 is less than 60 psi at 2.0 mL/min. The UTAC-ULP1 is less than 30 psi at 2 mL/min, and the UTAC-XLP1 is less than 10 psi at 2.0 mL/min. The large resin particle size (17  $\mu\text{m}$ ) in the UTAC-LP1, UTAC-ULP1, and UTAC-XLP1 makes it possible to perform manual injections onto the concentrator. Syringes with up to 3 mL capacities can be used to manually push samples through the UTAC-LP1, UTAC-ULP1, or UTAC-XLP1. It takes approximately 1 minute to manually push 3 mL of a sample through the UTAC-LP1. The other formats of the UTAC require less than 1 minute since these columns have a relatively lower backpressure rating.

The UTAC columns can be used with hydroxide, carbonate eluents, and borate eluents, with or without solvent, to concentrate samples on either 4-mm or 2-mm analytical systems.

The UTAC-LP1, UTAC-ULP1, and UTAC-XLP1 have 10-32 threaded PEEK™ end fittings for use with 10-32 ferrule/bolt liquid line fittings. To install a component with 1/4-28 ports, one needs to obtain or make one or more transition lines between 10-32 and 1/4-28 threaded ports. Dionex recommends the use of PEEK lines with a PEEK ferrule/bolt fitting on one end and a 1/4-28 fitting on the other end.



### WARNING

*Always use the high pressure pulse damper (Dionex P/N 043945) after the DQP pump or DXP pump to ensure the concentrator column does not get exposed to pump pulsations. It is possible to damage the resin when exposed to high pump pulsations.*

**Assistance is available for any problem during the shipment or operation of Dionex instrumentation, columns, and consumables through the Dionex North America Technical Call Center at 1-800-DIONEX-0 (1-800-346-6390) or through any of the Dionex Offices listed in “Dionex Worldwide Offices” on the Dionex Reference Library CD-ROM.**

**TABLE 1**  
**IonPac UTAC-LP1, UTAC-ULP1, and UTAC-XLP1 Concentrator Column Packing Specifications**

Column	Particle Diameter	Substrate X-Linking	Latex Diameter	Latex X-Linking	Column Capacity	Functional Group	Hydrophobicity
UTAC-LP1 4-mm	17	55	85	6	25	Alkanol quaternary ammonium	Very low
UTAC-ULP1 5-mm	17	55	85	6	25	Alkanol quaternary ammonium	Very low
UTAC-XLP1 6-mm	17	55	85	6	25	Alkanol quaternary ammonium	Very low

**TABLE 2**  
**IonPac UTAC-LP1, UTAC-ULP1, and UTAC-XLP1 Concentrator Column Operating Parameters**

Column	Typical Backpressure MPa at 30 °C	Standard Flow Rate mL/min	Maximum Flow Rate mL/min
UTAC-LP1 4-mm	≤ 60 (0.413)	1.0	3.0
UTAC-ULP1 5-mm	≤ 30 (0.206)	1.0	3.0
UTAC-XLP1 6-mm	≤ 10 (0.068)	1.0	3.0

## SECTION 2 – INSTALLATION

### 2.1. Column Description

A. The IonPac Ultra Trace Anion Concentrator – Low Pressure (UTAC-LP1) column consists of the following components.

1. Bed Support Assembly (P/N 042955)
2. 10-32 Ferrule Column End Fitting (P/N 052809)
3. 10-32 Ferrule Plug (P/N 042772)

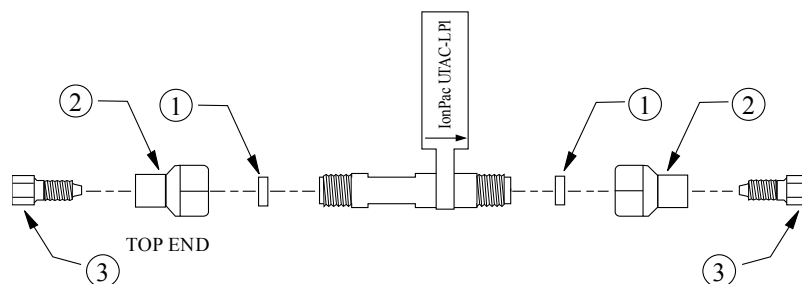

**FIGURE 1**  
UTAC-LP1 Column Components

B. The IonPac Ultra Trace Anion Concentrator – Ultra Low Pressure (UTAC-ULP1) columns consist of the following components.

1. Bed Support Assembly (P/N 042955)
2. 10-32 Ferrule Column End Fitting (P/N 052809)
3. 10-32 Ferrule Plug (P/N 042772)
4. Zitex Membrane (P/N 048297)

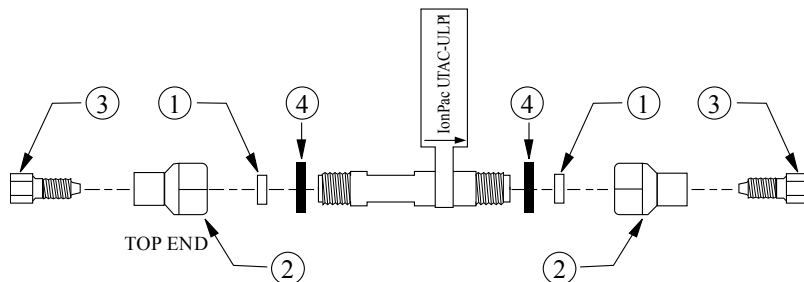

**FIGURE 2**  
UTAC-ULP1 Column Components

C. The Ultra Trace Anion Concentrator – Extremely Low Pressure (UTAC-XLP1) column consists of the following components.

1. 10-32 Ferrule Plug (P/N 042772)
2. Column Body 6 x 16 mm (P/N 063561)  
[Column fitted with frit]
3. Bed Support Assembly (P/N 063688)
4. Zitex Membrane (P/N 048297)
5. 9-mm Column End Fitting (P/N 048298)

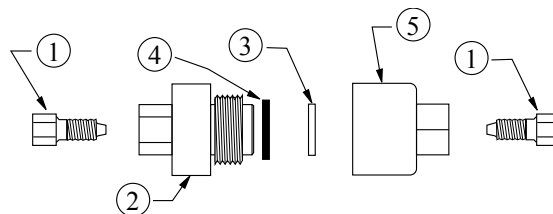
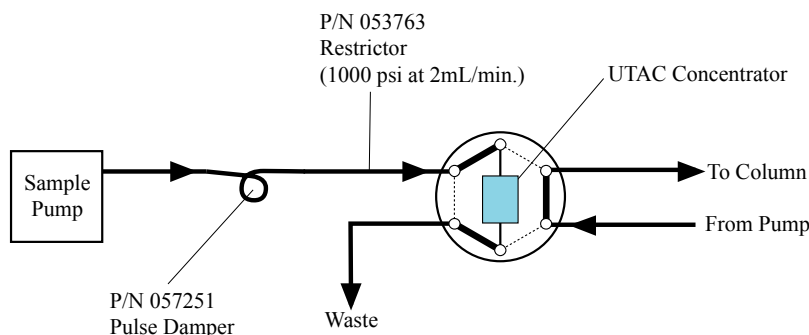

**FIGURE 3**  
UTAC-XLP1 Column Components



## SECTION 3 – UTAC SETUP

Figure 4 illustrates the recommended setup for the Ultra Trace Anion Concentrator.



**FIGURE 4**  
Recommended setup for UTAC

## SECTION 4 – OPERATION

### 4.1. Sample Loading



**WARNING**

*Always use the high pressure pulse damper (Dionex P/N 043945) after the DQP pump or DXP pump to ensure the concentrator column does not get exposed to pump pulsations. It is possible to damage the resin when exposed to high pump pulsations.*



**WARNING**

*To prevent overloading the UTAC-LP1, UTAC-ULP1, or UTAC-XLP1, and/or loss of sample analytes, determine the concentration linearity over the desired analytical concentration range. See Section 3.4.1, “Capacity Consideration of Concentrators.”*

Sample loading can be performed manually with a < 3 mL syringe. It takes approximately 1 minute to manually inject 3 mL of sample through the UTAC-LP1.

Alternately, one can use a separate positive displacement pump such as the Dionex DQP pump (P/N 035250) with a restrictor (P/N 053763) installed as shown in Figure 4. When using a pump, ensure that a high pressure damper is used. Pump flow rates of approximately 3 mL/min can be used while maintaining sample concentration to ensure good quantification.



**WARNING**

*The flow direction during the concentration step is critical. In order to ensure optimal system performance, it is recommended that concentration always be performed in a counter current direction to the eluent flow.*

After the sample has been loaded onto the UTAC-LP1, UTAC-ULP1, or UTAC-XLP1 in the direction opposite to the eluent flow, it is then eluted with eluent onto the guard and analytical columns (see Figure 5, “Loading the UTAC-LP1, UTAC-ULP1, or UTAC-XLP1 Column”). Loading the sample in the opposite direction to the eluent flow ensures that the analyte ions are concentrated on the bottom end of the concentrator column upon loading. Upon injection, the analyte ions are eluted off the concentrator column by the eluent in a tight plug and is injected onto the guard and analytical column for further analysis. In this configuration the concentrated ions do not undergo any chromatographic separation in the concentrator column. When injected, all of the ions are rapidly eluted off of the UTAC columns, and onto the guard and analytical columns. On the other hand, if the sample is loaded onto the UTAC-LP1, UTAC-ULP1, or UTAC-XLP1 in the same flow direction as the eluent flow, the anions are concentrated at the head of the column rather than at the bottom. When injected, the anions begin chromatographic separation on the concentrator before reaching the guard and analytical columns. Therefore, the retention time of the analytes would be significantly longer than a standard loop injection. Normally the function of the concentrator is to strip the ions of interest from the sample matrix and not to act as an analytical column.

Figure 5 shows the configuration for sample loading using a Rheodyne valve.

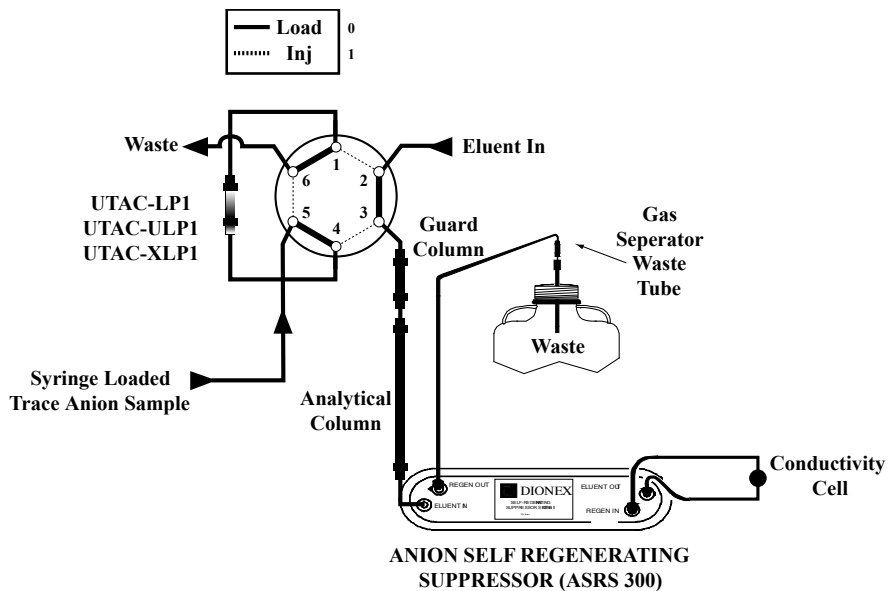

**FIGURE 5**  
**Configuration for Determining Trace Levels of Anions**

Figure 6 shows the configuration for sample loading using a slider valve.

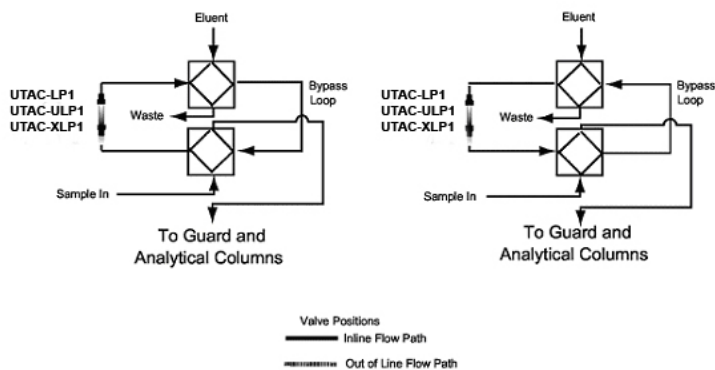

**FIGURE 6**  
**Loading the UTAC-LP1, UTAC-ULP1, or UTAC-XLP1 Column**

## 4.2. Reagent and Sample Handling

The following sections focus on critical points that must be followed when using the UTAC-LP1, UTAC-ULP1, or UTAC-XLP1 concentrator columns. Proper consideration of these points will enable the analyst to obtain accurate and reproducible results at trace analyte levels.

### 4.2.1. Water Quality

All water used in the preparation of standards and eluents must be deionized water with a specific resistance of 18.2 megohm-cm. The quality of the dilution water must be determined by Ion Chromatography since even deionized water with a specific resistance of 18.2 megohm-cm may contain trace levels of the ions of interest. To do this, analyze the water in exactly the same manner as the sample.

### 4.2.2. Sample Collection and Storage



*Never use plastic syringes with rubber pistons for any loading of trace ions. These materials cause non-reproducible results.*

At trace analyte concentration levels ( $\mu\text{g/L}$ ), chances of contamination during collection or storage are high. Every container and every procedural step constitutes a potential source of contamination. Polystyrene containers with leak-tight caps can be used to store 1 to 5  $\mu\text{g/L}$  levels of inorganic and organic anions for up to 8 days. Recommended storage vessels are Corning tissue culture flasks. The following procedure should be used for storage of  $\mu\text{g/L}$  level samples.

- A. Rinse the polystyrene container and cap twice with deionized water having a specific resistance of 18.2 megohm-cm. Fill the container until it overflows, cap it securely, and soak for 4 hours.
- B. Empty the container and refill it with deionized water having a specific resistance of 18.2 megohm-cm. Cap the container securely. It should remain filled at least 24 hours before sample collection.
- C. Empty the container and rinse it twice with the sample to be collected. Fill the container with the sample until it overflows and then cap the container securely. Be sure that the sample line does not touch the container.

### 4.2.3. Standards

It is good practice to run standards at the beginning, middle, and end of each day to ensure constant instrument response. Because external standard quantification is used, it is critical that standard solutions are correctly prepared.

- A. 1,000 mg/L (1 mg/L = 1 ppm) stock standard solutions should be prepared by accurately weighing amounts of salts as described in the instrument manual. These solutions are stable over a period of several months.
- B. 1 mg/L stock standard solutions may be prepared by diluting 1 mL of 1,000 mg/L stock standard to 1,000 mL in a volumetric flask. These solutions should then be transferred to clean polystyrene containers. They may be stored for up to one month.
- C. 1  $\mu\text{g/L}$  working standard solutions may be prepared by diluting 1 mL of the 1 mg/L stock standard to 1,000 mL. These working standards are stored in polystyrene containers. They are stable up to 8 days, but Dionex recommends daily preparation since standard response is critical in the analysis.

### 4.3. Concentrator Capacity

As in all ion exchange systems, the resin has a finite capacity. It can strip a given amount of ions from water. When the capacity of the concentrator is exceeded, the stripping will not be quantitative. This condition is referred to as column overload.

When estimating the capacity of a concentrator, one must remember that the column is used in a dynamic state where the liquid containing the analytes is flowing over the resin at a finite rate. This reduces the capacity somewhat since the analyte ions have less time to interact with the resin surface.

Low concentrator column capacity creates the following practical implications.

- A. Trace analysis of an analyte is difficult in the presence of  $\mu\text{g/L}$  concentrations of species which exhibit higher or similar affinities for the resin. If the dynamic column capacity is exceeded, high affinity ions will displace the analytes on the ion exchange sites and result in their elution to waste during the loading process.
- B. Conversely, qualitative analysis of ions with higher affinities for the resin in the presence of high concentrations of ions with low affinities is possible. Again, the key to successful analysis is that the ionic content of the high affinity ion to be quantitated may not exceed the effective column capacity.
- C. Do not dilute samples to be concentrated in eluent because the eluent ions elute the ions of interest.
- D. A plot of response versus concentration should be generated as in Figure 7, "Linearity Determinations for Concentrator Injection", for the determination of the maximum amount of sample or standard that can be quantitatively loaded. In Figure 7, the break in the curve where linearity starts to change is at a concentration volume of 2 mL of 30  $\mu\text{g/L}$  fluoride. For practical purposes, the amount concentrated for a series of samples should be 75% of this value. This will ensure that there is a safety margin built into the concentration process in case a sample in a series of concentration experiments has a slightly higher ionic concentration.

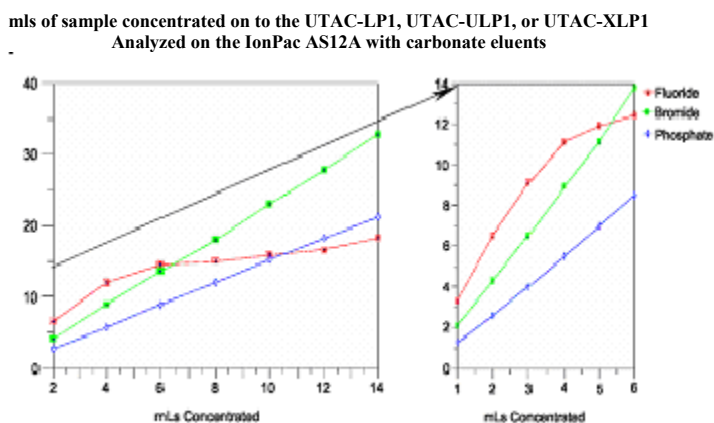

**FIGURE 7**  
**Linearity Determinations for Concentrator Injection**

### 4.3.1. Determination of the Concentrator Column Breakthrough Volume

The breakthrough volume of an analyte ion is that volume of sample which causes an ion of interest to be eluted from, rather than retained or concentrated on, the concentrator column.

The breakthrough volume for a concentrator column is usually defined as the volume of sample necessary to elute the most weakly retained ions of interest in the sample. The more strongly retained ions in the sample, such as sulfate, can elute the more weakly retained ions in the sample, such as fluoride.

It is also possible for a high concentration of a weakly retained ion such as chloride to elute a more strongly retained ion present at low concentration. This can occur if one is attempting to concentrate trace ions in a concentrated matrix.

The breakthrough is dependent upon several factors.

- A. The volume of sample loaded.
- B. The rate at which the sample is loaded.
- C. The pH of the sample.
- D. The ionic strength of the sample.
- E. The amount and capacity of resin in the column.

The breakthrough volume is determined as follows.

- A. Prepare 1 L of a solution that closely simulates the type of sample to be analyzed. For example, if the sample contains high levels of sulfate, the simulated sample should also contain sulfate. The sulfate ion will act as an eluent (E2).
- B. Prepare a 1 mg/L standard of the first eluting ion of interest (e.g., F).
- C. Set up the Ion Chromatograph, as shown in Figure 8, "Linearity Determinations for Concentrator Injection."
- D. Equilibrate the UTAC-LP1, UTAC-ULP1, or UTAC-XLP1 with the eluent (E1) to be used in the analysis. Set the flow rate necessary to achieve a stable baseline and wash the column in this manner for at least 10 minutes.
- E. Switch to the simulated sample as an eluent (E2). Without delay, manually inject 50  $\mu$ L of the 1 mg/L standard.
- F. Record the resulting chromatogram and calculate the breakthrough volume, as shown in Figure 9, "Typical Data Obtained in the Determination of the Breakthrough Volume."
- G. For practical purposes, the volume concentrated should be below 75% of the breakthrough volume.

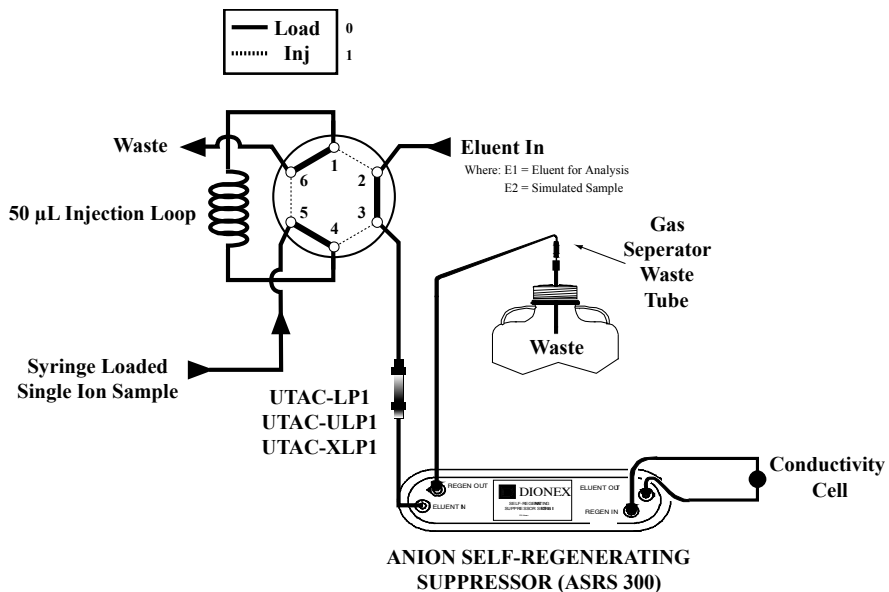

**FIGURE 8**  
**Linearity Determinations for Concentrator Injection**

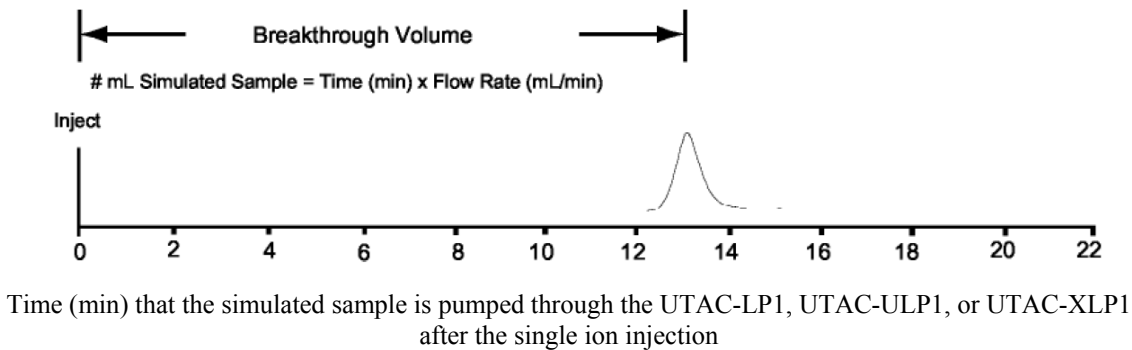

**FIGURE 9**  
**Typical Data Obtained in the Determination of the Breakthrough Volume**

## SECTION 5 – EXAMPLE APPLICATIONS

### 5.1. Manual Concentration on UTAC-LP1 versus 1 mL Direct Injection

The following examples demonstrate the advantages of sample concentration with low sensitivity detection versus direct injection with high sensitivity detection.

Sample Loop Volume: See Chromatogram  
 Column: Ion Pac AS18 Analytical Column + Ion Pac AG18 Guard Column  
 Eluent: 23 mM Potassium Hydroxide  
 Eluent Flow Rate: 1.0 mL/min  
 Temperature: 30 °C  
 SRS Suppressor: Anion Self-Regenerating Suppressor, ASRS 300 (4-mm), set current 57 mA.  
 Auto Suppression or MMS Suppressor: Recycle Mode  
 MMS Regenerant: Anion Micro Membrane Suppressor, AMMS III (4-mm)  
 MMS Regenerant: 50 mN H<sub>2</sub>SO<sub>4</sub>  
 or AES Suppressor: Anion Atlas Electrolytic Suppressor, AAES, set current 75 mA

Peaks	mg/L (ppm)
1. Fluoride	0.05
2. Acetate	0.25
3. Formate	0.01
4. Chlorite	0.05
5. Chloride	0.03
6. Nitrite	0.05
7. Carbonate	0.20
8. Bromide	0.10
9. Sulfate	0.10
10. Nitrate	0.10
11. Chlorate	0.10

1 mL Injected onto the UTAC-LP1 for concentration.

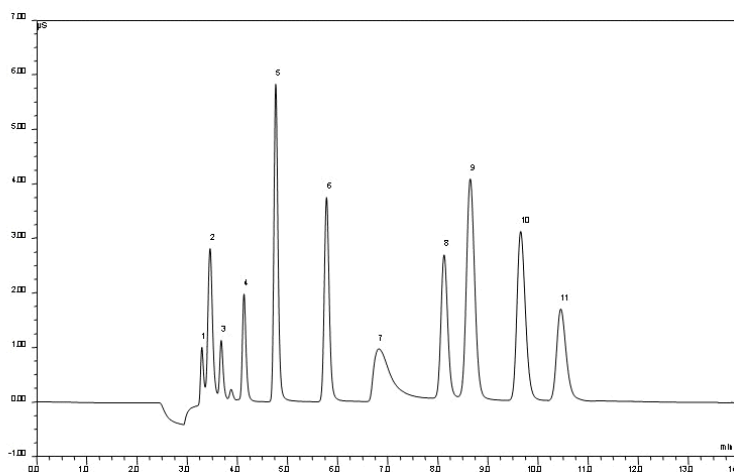

25 µL Direct Injection

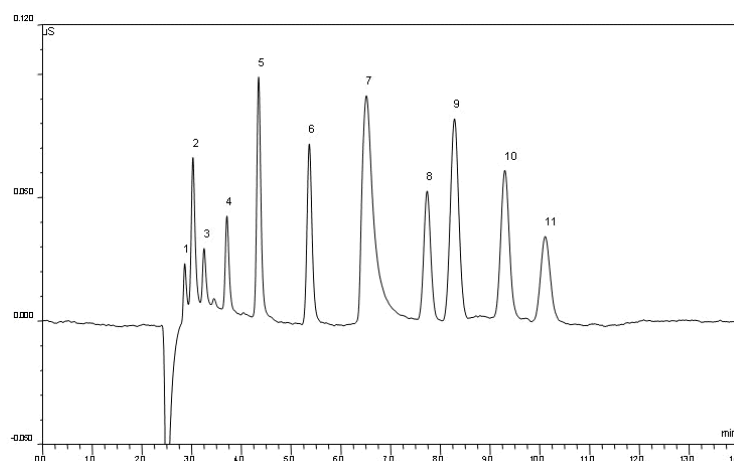

**FIGURE 10**  
**Manual Concentration on UTAC-LP1 versus Direct Injection**

### 5.2. Manual Concentration on UTAC-LP1 versus 2 mL Direct Injection

The following examples demonstrate the advantages of sample concentration with low sensitivity detection versus direct injection with high sensitivity detection.

Sample Loop Volume: See Chromatogram  
 Column: Ion Pac AS12A Analytical Column + Ion Pac AG12A Guard Column  
 Eluent: 2.7 mM Na<sub>2</sub>CO<sub>3</sub>/0.3 mM NaHCO<sub>3</sub>  
 Eluent Flow Rate: 1.5 mL/min  
 SRS Suppressor: Anion Self-Regenerating Suppressor, ASRS 300 (4-mm), set current 22 mA.  
 Auto-Suppression or MMS Suppressor: Recycle Mode  
 Anion Micro Membrane Suppressor, AMMS III (4-mm)  
 MMS Regenerant: 50 mN H<sub>2</sub>SO<sub>4</sub>  
 or AES Suppressor: Anion Atlas Electrolytic Suppressor, AAES, set current 28 mA.

Analyte	µg/L (ppb)
1. Fluoride	40
2. Chloride	50
3. Nitrite	100
4. Bromide	200
5. Nitrate	200
6. Phosphate	300
7. Sulfate	200

2 mL Injected onto the UTAC-LP1 for concentration.

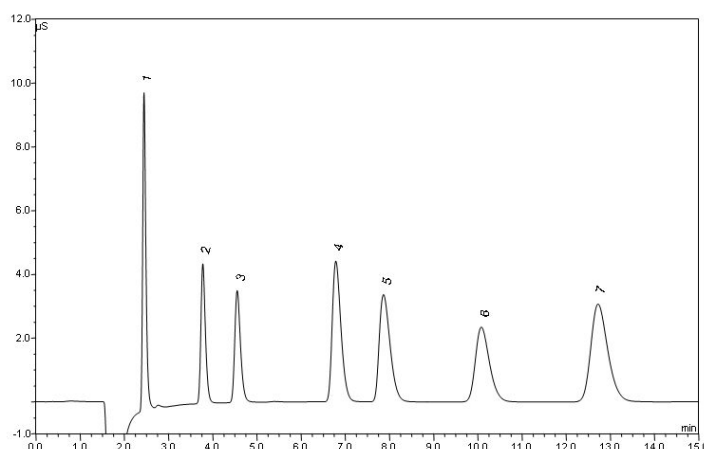

25 µL Direct Injection

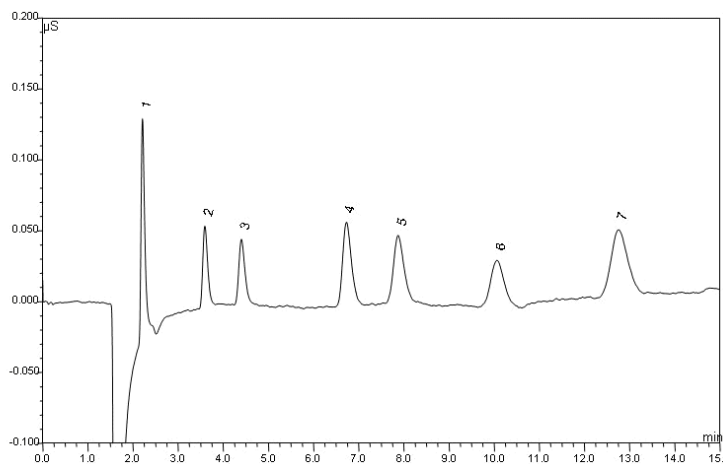

**FIGURE 11**  
**Manual Concentration on UTAC-LP1 versus Direct Injection**



## SECTION 6 – TROUBLESHOOTING GUIDE

The purpose of the Troubleshooting Guide is to help you solve operating problems that may arise while using the UTAC-LP1, UTAC-ULP1, and UTAC-XLP1 columns. For more information on problems that originate with the Ion Chromatograph, refer to the Troubleshooting Guide in the appropriate operator's manual. If you cannot solve the problem on your own, call your nearest Dionex Regional Office (see, "Dionex Worldwide Offices" on the Dionex Reference Library CD-ROM).

### 6.1. High Backpressure from a Contaminated Inlet Bed Support

If the UTAC-LP1, UTAC-ULP1, or UTAC-XLP1 column displays high backpressure, the bed support in the column inlet may be contaminated. A contaminated bed support may also lead to loss of peak asymmetry.



**WARNING**

*For proper operation in the SP10 Auto Neutralizer, the UTAC columns should generate no more than 70 psi of backpressure at a flow rate of 0.5 mL/min. Always use the high pressure pulse damper (Dionex P/N 043945) after the DQP pump or DXP pump to ensure the concentrator column does not get exposed to pump pulsations. It is possible to damage the resin when exposed to high pump pulsations.*



**WARNING**

*If any of the column packing becomes lodged between the end of the column and the bed support washer assembly, no amount of tightening will seal the column. Be sure that the washer and the end of the column are clean before screwing the end fitting back on to the column.*

Follow the instructions below to change the bed support assembly using one of the two spare bed support assemblies included in the ship kit provided with the column.

- A. Disconnect the column from the system.
- B. Using two open-end wrenches, carefully unscrew the inlet (top) column end fitting.
- C. Turn the end fitting over and tap it against a bench top or other hard, flat surface to remove the bed support and seal assembly. If the bed support must be pried out of the end fitting, use a sharp pointed object such as a pair of tweezers, but be careful that you **DO NOT SCRATCH THE WALLS OF THE END FITTING**. Discard the old assembly.
- D. Place a new bed support assembly in the end fitting. Before assembling, clean the column body threads and the end fitting threads of any resin particles. If any resin remains on the threads of either the column body or the end fitting, the column may leak regardless of how tight the end fitting is turned onto the column body. Use the end of the column to carefully start the bed support assembly into the end fitting.
- E. Screw the end fitting back onto the column. Tighten it finger tight and then, using two open-end wrenches, tighten it an additional 1/4 turn (25 in x lb). Tighten further only if leaks are observed.
- F. Reconnect the column to the system and resume operation.

Column	UTAC-LP1 (P/N)	UTAC-ULP1 (P/N)	UTAC-XLP1 (P/N)
Bed Support Assembly	042955	042955	063688
End Fitting (10-32 Ferrule Type)	052809	052809	048298

## 6.2. High Background, Noise, or Baseline Instability

Normally, problems such as high background, noise, or baseline instability will not be attributable to the UTAC-LP1, UTAC-ULP1, or UTAC-XLP1 column. These problems usually originate in either the analytical column or the post-column detection chemistry. Before checking the UTAC-LP1, UTAC-ULP1, or UTAC-XLP1 as the source of system background noise, consult the appropriate troubleshooting sections in the analytical column's Product Manual, the Ion Chromatograph Operator's Manual, and the detector manual.

If the source of the high background noise is isolated to the UTAC-LP1, UTAC-ULP1, or UTAC-XLP1, then proceed with the following steps.

- A. Be sure that the UTAC column is not leaking.
- B. Be sure that the eluents are correctly formulated.
- C. If using an Anion Micro Membrane Suppressor III (AMMS® III), be sure that the regenerant is formulated correctly.
- D. Be sure that the eluents are made from chemicals with the recommended purity (see Section 3, "Operation").
- E. Be sure that the deionized water used to prepare the reagents has a specific resistance of 18.2 megohm-cm.
- F. Be sure that the Anion Self-Regenerating Suppressor (ASRS® 300), the Anion Micro Membrane Suppressor (AMMS III), or the Anion Atlas® Electrolytic Suppressor (AAES) is suppressing correctly by bypassing the UTAC column and making direct injections.

## 6.3. Poor Peak Shape

In some instances, poor peak shape in Ion Chromatography may be caused by a contaminated UTAC column. To clean the UTAC Column, see, "Column Cleanup of Polyvalent Anions and Base-Soluble Contaminants" in the Column Care Appendix.

When pursuing pre-concentration with a pump, ensure that the pump has a pulse damper installed. Failure to dampen the pump pulsations may result in damage to the UTAC columns.

**Assistance is available for any problem during the shipment or operation of Dionex instrumentation, columns, and consumables through the Dionex North America Technical Call Center at 1-800-DIONEX-0 (1-800-346-6390) or through any of the Dionex Offices listed in "Dionex Worldwide Offices" on the Dionex Reference Library CD-ROM.**

---

## APPENDIX A COLUMN CARE

### ***A.1 Recommended Operating Pressures***

Operating a column above its recommended pressure limit can cause irreversible loss of column performance. The maximum recommended operating pressure for the IonPac Ultra Trace Anion Concentrator (UTAC) columns is 3,000 psi.

### ***A.2 Column Start-up***

The column is shipped with 20 mM NaOH as the storage solution. Flush the column for 30 minutes with eluent before attempting to concentrate sample. Pump the effluent directly to a waste container while washing the column. DO NOT pump this effluent through the guard column, analytical column, and/or the suppressor.

### ***A.3 Column Storage***

The UTAC should be stored in the base form. Flush approximately 5 mL of 20 mM NaOH through the UTAC column.

### ***A.4 Column Cleanup of Polyvalent Anions and Base-soluble Contaminants***

- A. Prepare a 500 mL solution of 0.5 M NaOH.
- B. Disconnect the guard, analytical columns and the suppressor from the injection valve and the Conductivity Module. Disconnect the Gradient Mixer or Anion Trap Column from the Gradient Pump. Connect the Ultra Trace Anion Concentrator (UTAC) column directly to the Gradient Pump. Direct the effluent from the UTAC directly to a waste container.
- C. Set the flow rate to 1 mL/min.
- D. Pump the 0.5 M NaOH solution through the column for 15-30 minutes.
- E. Equilibrate the UTAC with eluent for 15 minutes at 1 mL/min before resuming normal operation.
- F. Reconnect the anion guard, analytical column and the suppressor between the injection valve and the Conductivity Module. Reconnect the Gradient Mixer or Anion Trap Column between the Gradient Pump and the Injection Valve. Resume operation.

### ***A.5 Column Cleanup of Organic/Anionic Contaminants***

- A. Prepare a 500 mL solution of 200 mM HCl/80% acetonitrile.
- B. Disconnect the guard, analytical columns and the suppressor from the injection valve and the Conductivity Module. Disconnect the Gradient Mixer or Anion Trap column from the Gradient Pump. Connect the Ultra Trace Anion Concentrator (UTAC) column directly to the Gradient Pump. Direct the effluent from the UTAC directly to a waste container.
- C. Set the flow rate to 1 mL/min.
- D. Pump the 200 mM HCl / 80% acetonitrile solution through the column for 15-30 minutes.
- E. Equilibrate the UTAC column with eluent for 15 minutes at 1 mL/min before resuming normal operation.
- F. Reconnect the Anion Guard, analytical column and the suppressor between the injection valve and the Conductivity Module. Reconnect the Gradient Mixer or Anion Trap Column between the Gradient Pump and the Injection Valve. Resume operation.